

## Energy Requirements for Combine Machine to Strip Tillage and Planting

Abo-Habaga, M. M. E.<sup>1</sup>; Kh. A. A. Khadr<sup>2</sup>; M. Ghazy<sup>1</sup> and H. S. Helal<sup>2</sup>

<sup>1</sup> Agric. Eng. Dept., Fac. of Agric. Mansoura Univ. Egypt.

<sup>2</sup> Agric. Eng. Ins., El-Dokki, Giza., Egypt.



### ABSTRACT

Field experiments were carried out at "Elbasatin station "Sabahia site, Alexandria Governorate, in area of about five feddans with using a local manufacture combined implement for strip tillage and at same time corn. The corn variety of (Giza 125) that planting, during the summer season of 2016-2017. The results of this study indicated that the energy requirements for combined implement without rotary units increased from 19.882 to 40.813 mJ.feddans<sup>-1</sup> by increasing the plowing depth from 17 cm to 22 cm, respectively. Whereas the energy requirements for combine machine with rotary unit increased from 32.375 to 47.668 mJ.feddans<sup>-1</sup> with increasing the operating speed from 0.44 to 0.94 m.s<sup>-1</sup> and increased from 36.45 to 62.307 mJ.feddans<sup>-1</sup> as the operating speed increased from 0.44 to 0.94 m.s<sup>-1</sup> and increasing from 56.889 to 66.157 mJ.feddans<sup>-1</sup> during increasing the plowing depth from 17 cm to 22 cm, respectively.

### INTRODUCTION

Primary and secondary tillage aim to prepare a good seedbed which helps the germination of seeds, create a suitable seed-bed for plant growth, control the weeds effectively. Disadvantages of traditional tillage are consuming a high power, high fuel consumption, causing a hard pan soil due to soil compaction below the tilling depth and increasing the operating cost and energy requirements. So the reasons to study the effect of using a combined unite for strip seedbed preparation and rows planting is to reduce the previous disadvantages. Strip tillage helps to reduce the power required for plowing the planting area, resulting in minimizing such as fuel consumption, tire wearing, and soil compaction as compared with traditional tillage. Upadhyaya *et al* (2001) mentioned that the combination tillage equipment lessen fuel consumption. Fuel savings ranged from 19% to 81% with an average of 50%. Time savings ranged from 67% to 83% with average 72%. Khadr (2004) found that the draft force and the unit draft depend on the operational speed, both of them increases as the forward speed increasing. On the other hand, the overall energy efficiency and the fuel consumption increase with increasing the forward speed. ASL (2006) mentioned that the power consumption increased by increasing both of the number of the rotary blades and the operating speed. He added also that, the rotary shaft torque increased by increasing both of rotary shaft rotational speed and forward speed. Sahu and Raheman (2006) reported that the total draft requirements of combined tillage implements were significantly affected by depth, speed of operation and soil condition. Also found that the draft of all the tillage implements increased with increases soil compaction, depth and speed. On the other hand, the reverse trend was obtained for  $\lambda$  with the same parameters. Hegazy and Motallb (2008) reported that the draft and field capacity increased when forward speed increase also the fuel consumption was increased when the plowing depth increase and draft increases. Dhakane *et al* (2010) reported that the combined implements reduced the draft compared to disc harrow and MB plough. The comparative field performance indicates that the combination machine offers an advantage over a traditional system in terms of field

capacity, time of operation, fuel consumed, energy required and cost of operation. Al Suhaibani and Ghaly (2013) indicated that, the draft increased by increasing the plowing depth and the forward speed. Matin *et al* (2014) reported that the peak and the average power requirements increased with the increases of the operating speed. Machindra and Raheman (2016) reported that the draft of combined tillage implement increased with decreases speed ratio but increased at by increasing each of depth and forward speed. On other hand, the torque requirement of combined tillage implements increased with increases operating width.

The objective of this study is to construct and manufacture a combined machine for strip tillage and planting. Also, to reduce the energy requirements under Egyptian cultivation conditions.

### MATERIALS AND METHODS

The field experiments were carried out using the combination machine and planting at "Elbasatin station "Sabahia site, Alexandria Governorate, during summer season of 2016-2017. The experimental area was about five feddans and planted crop was corn was corn (Giza 125). The local manufactured unit used in the study including a frame with two installed units having interred distance of 66 cm. Each unit consists of a chisel shank in front for primary tillage followed by a rotary unit consisting of 4L shape shares as secondary tillage and followed by a planter as showmen in Fig (1).

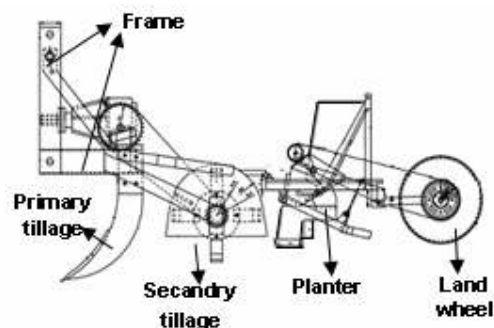

Fig. 1. Schematic of combined machine.

**Experimental conditions:**

The manufactured machine was experimented at two operating depths of 17 and 22 cm and under four operating speed of 0.44, 0.61, 0.83 and 0.94 m/s.

**Draft measurements:**

The draft was measured using a three point hitch dynamometer as shown in Fig2.

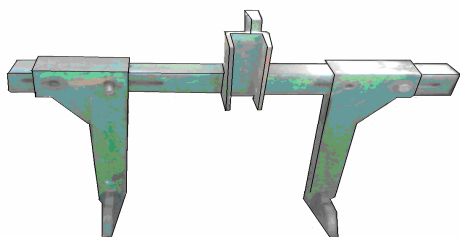

**Fig. 2. Three point hitch dynamometer.**

**Torque and rotational speed:**

The torque and rotational speed of rotary unit were measured by using a torque transducer as shown in Fig. 3.

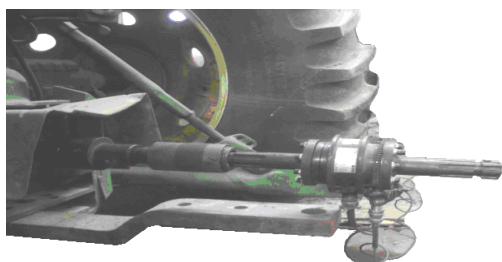

**Fig. 3. Torque transducer.**

**Power on tractor PTO:**

After measuring the torque (kN.m) and counting from the principle equation the number of revolution PTO (rpm) the power can be calculated as follow:

$$Power (PTO) = \frac{2\pi NT}{60}, \quad kW$$

Where:-

T: Torque (kN. m)

N: revolution (r.p.m)

**Drawbar power:**

The drawbar power for combined implement was determined using the following equation:

$$P = D \times V, \quad kW.$$

Where: P: Required power, kW.

D: Draft, kN.

V: Operating speed, m.s<sup>-1</sup>.

**Total power requirements = Tractor PTO power + Drawbar power**

**Fuel consumption:**

The fuel consumption was determined through starting the operating with tractor full fuel tank, the operating time for each treatment was determined by using a stop watch and refuel tractor tank to its full capacity at the same fuel level before operating. The amount of fuel added to the fuel tank should be measured by using a graduated cylinder. The fuel consumption has been calculated as follow:

$$F_c = \frac{F_v}{T}, \quad L.h^{-1}$$

Where: F<sub>c</sub>: Fuel consumption L.h<sup>-1</sup>.

F<sub>v</sub>: Volume of fuel consumed, Liter.

T: time, h.

**Specific Energy:**

The specific energy was computed as the quotient of power and field capacity as follow:

$$Specific\ energy = \frac{Drawbar\ power\ (kW)}{Actual\ field\ capacity\ (fed.h^{-1})} \quad mj.feddan^{-1}$$

**RESULTS AND DISCUSSION**

**Effect of operating speed and depth on draft:**

Result in Fig. (4) indicated that the draft increased with increasing the operating speed. The draft requirements for combined machine without operating the rotary unit increased from 5.522 to 7.231, 8.319, 9.407 kN and 10.124 to 12.084, 12.91, 14.356 kN, also The draft requirements for combined machine with operating the rotary unit increased from as the operating speed increased from 2.613 to 3.498, 3.96, 4.387 kN and from 4.711 to 5.353, 5.994, 6.589 kN with increased the operating speed from 0.44 to 0.61, 0.83 and 0.94 m.s<sup>-1</sup> at operating depths of 17 cm and 22 cm respectively. The results showed that using the rotary unit led to decrease the draft requirements, this is due to that the rotary unit pushes the machine forward, which leads to reduce the draft required to operate the combine machine.

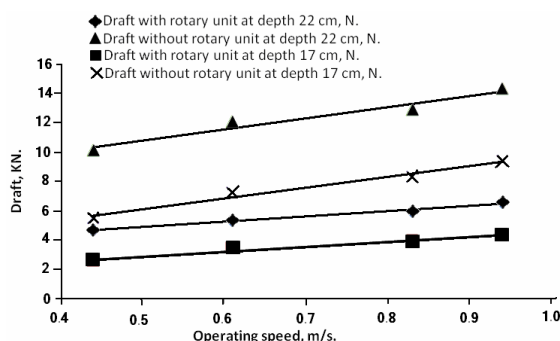

**Fig. 4. Effect of operating speed on draft requirement for combine machine at 17 cm and 22 cm operating depth.**

**Effect of operating speed and depth on drawbar power.**

Fig. (5) show the effect of operating speed on drawbar power for combine machine with and without rotary unit at different operating depth. The drawbar power for combined machine without rotary unit increased from 2.43 to 4.411, 6.905, 8.843 kW and from 4.455 to 7.396, 10.722, 13.95 kW, also the drawbar power for combined machine with rotary unit increased from 1.15 to 2.134, 3.294, 4.124 kW, and from 2.073 to 3.265, 4.975, 6.194 kW with increasing the operating speed increased from 0.44 to 0.61, 0.83 and 0.94 m.s<sup>-1</sup> at operating depths of 17 cm and 22 cm respectively.

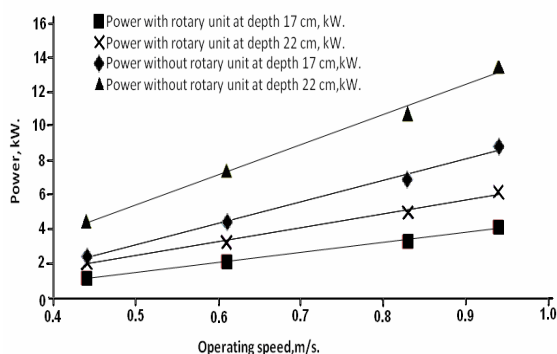

Fig. 5. Effect of operating speed on drawbar power for combine machine at 17 cm and 22 cm operating depth.

**Effect of operating speed and depth on tractor PTO power:**

Data in Fig. (6), indicated the effect of operating speed on PTO power required to operate the rotary unit in combine machine at 17 and 22 cm operating depth. The tractor PTO power required increased from 2.81 to 3.96, 4.90, 6.20 kW and from 4.88 to 6.06, 7.17, 8.14 kW with increased the operating speed from 0.44 to 0.61, 0.83 and 0.94 m.s<sup>-1</sup> at operating depth 17 and 22 cm respectively.

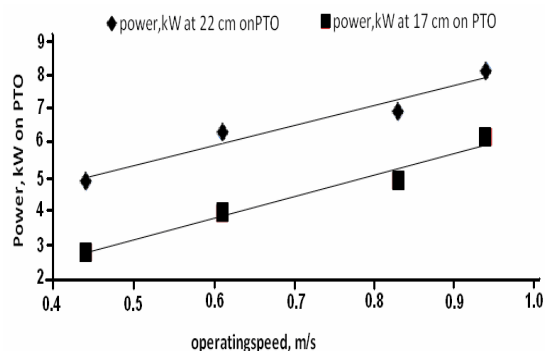
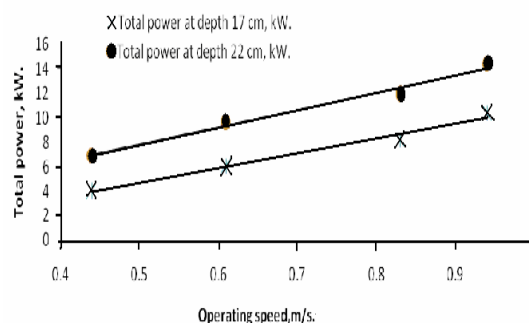

Fig. 6. Effect of operating speed on tractor PTO power on for rotary unit at 17 cm and 22 cm operating depth.

**Effect of operating speed and depth on total power requirements:**

Results in Fig. (7) indicated that the total power requirements for combine machine influenced with operating depth and speeds. The total power requirements increased from 3.957 to 6.094, 8.197, 10.328 kW at operating depth of 17 cm and from 6.953 to 9.575, 11.895, 14.334 kW at 22 cm operating depth with increasing the operating speed from 0.44 to 0.61, 0.83 and 0.94 m.s<sup>-1</sup> at respectively.

Fig (7) Effect of operating speed on total power required for combine machine at 17 cm and 22 cm operating depth.



**Effect of operating speed and depth on fuel consumption:**

Fig. (8) indicated that, increasing of operating speed from 0.44, 0.61, 0.83 and 0.94 m.s<sup>-1</sup> increased the fuel consumption from 11 to 12.5 to 13.9 L.h<sup>-1</sup> at operating depth of 17 cm, whereas the fuel consumption increased from 12 to 13.8, 15.29, 16.5 L.h<sup>-1</sup> as at depth of 22cm, respectively.

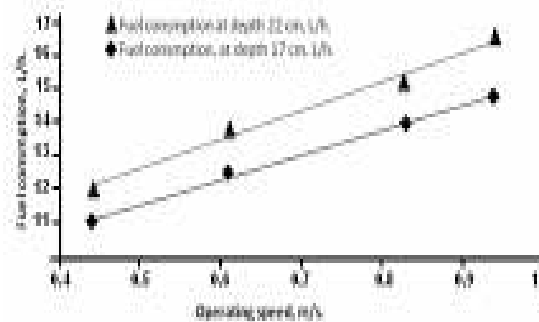

Fig. 8. Effect of operating speed on tractor fuel consumption to operate the strip machine for seed bed preparation and planting.

**Specific energy:**

The specific energy was computed as the quotient of total power and actual field capacity. Fig. (9) indicated that the energy requirements for operating the combined machine increased with the increase of operating speed. Calculated data showed that the total energy requirements increased from 32.38 to 37.83, 44.71, 47.67 mJ.fedd<sup>-1</sup> at depth of 17 cm and increased from 56.89 to 59.43, 64.88, 66.16 mJ.fedd<sup>-1</sup> at operating depth of 22 cm as the operating speed increased from 0.44 to 0.61, 0.83 and 0.94 m.s<sup>-1</sup> respectively.

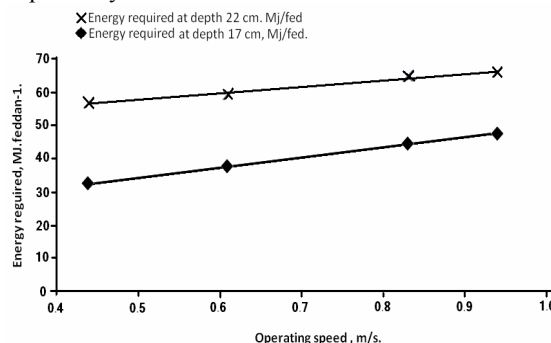

Fig. 9. Effect of operating speed on energy for combined machine at 17 and 22 cm operating depths.

## CONCLUSION

The results obtained from this study accented that that the operating speed and depth had a high effect on energy requirements for combined implement during strip tillage and planting.

Date showed that the using rotary unit reduces the drawbar power for combine machine by about 51% and 54.5% at operating depths of 17 and 22 cm respectively.

Using the combined machine reduces the time needed to prepare the seedbed and planting for comparison in order to complete it in successive stages.

The specific energy for operating combined machine increased from 32.38 to 47.67 mJ.feddan<sup>-1</sup> and from 56.89 to 66.16 mJ.feddan<sup>-1</sup> with increasing the operating speed from 0.44 to 0.94 m.s<sup>-1</sup> at operating depths of 17 and 22 cm respectively.

## REFERENCES

- ASL, J. H., (2006). Development and evaluation of rotary for strip-tillage (PhD thesis). India: Punjab Agricultural University.
- Al-Suhaibani, S. A. and A. E. Ghaly, (2013). Comparative Study of the Kinetic Parameters of three chisel plows operating at different depths and Forward Speed in a Sandy Soil. The International Journal of Engineering and Science (IJES) .Volume.2.Issue, 7, Pages,42-59.2013.
- Dhakane, A .D, P. A .Turbatmath and V. Pandey, (2010). Comparative performance of single pass implement with a conventional machine system. International Journal of Agricultural Engineering. Vol.3 No.1 (April. 2010): 94-100.

Hegazy, R. and I. A. Motallb, (2008). Determination of the suitable parameters for modified chisel plough a part for combination tillage unit. CIGR - International Conference of Agricultural Engineering XXXVII Congresso Brasileiro de Engenharia Agricola Brazil, August 31 to September 4, 2008.

Khadr, K.H. A. A., (2004). Energy requirements for some seed-bed preparation implements under Egyptian conditions. Modern Technology in Agric. Eng. Researches and Application, The 12<sup>th</sup> Annual Conference of Misr Society of Agr. Eng., October 2004.

Matin, M. A., J. M. Fielke, and J. M. A. Desbiolles, (2014). Furrow parameters in rotary strip-tillage: Effect of blade geometry and rotary speed. Biosystems Engineering, Science Direct 118: 7–15.

Machindra, A. R., and H. Raheman, (2016). Investigations on power requirement of active-passive combination tillage implement Engineering in Agriculture, Environment and Food (2016) 1-10.

Smith, L.A. (1993). Energy requirements for selected crop production. Soil & Tillage Research vol. 25 (4): 281-299.

Sahu, R. K., and H. Raheman, (2006). An approach for draft prediction of combination tillage implements in sandy clay loam soil. Soil & Tillage Research 90 (2006) 145–155.

Upadhyaya, S.K., K. P. Lancas, A. G. Santos-filho, and N. S. Raghuvanshi, (2001). One- pass tillage equipment outstrips conventional tillage method. California, Set.-Oct. 2001. Vol.55, No. 5.

**متطلبات الطاقة لآلة مركبة للحرث الشراحي والزراعة**  
مصطفى محمد أبو حياجة<sup>1</sup>، خفاف أبو العلا عبدالعزيز خضر<sup>2</sup>، محمد ابراهيم غازي<sup>1</sup> وهلال سامي هلال علي<sup>2</sup>  
<sup>1</sup> قسم الهندسة الزراعية – كلية الزراعة – جامعة المنصورة  
<sup>2</sup> معهد بحوث الهندسة الزراعية – مركز البحوث الزراعية – الدقى

تم اجراء التجارب الحقلية باستخدام آلة مجمعة للحرث الشراحي فى مزرعة البساتين بمنطقة الصبحية ، محافظة الاسكندرية، خلال الموسم الزراعي ٢٠١٦-٢٠١٧ وكانت المساحة التجريبية حوالى خمسة افدنة وكان المحصول المنزرع الذرة (جيزة ١٢٥). تم تطوير آلة مركبة وتصنيعها محليا فى ورشة خاصة بمنطقة النهضة- محافظة الاسكندرية وتتكون من اطار مثبت عليا وحدتين المسافة بينهما ٦٦ سم كل وحدة تتكون من سلاح حفار للحرث الرئيسى يليه وحدة دورانية تتكون من ٤ اسلحة على شكل حرف (L) عرض تشغيلها ٢٠ سم للحرث الثانوى ويليه وحدة زراعة فى جور. تم اختبار الآلة المركبة عند اعماق حرث رئيسى ١٧، ٢٢ سم مع سرعات تشغيل ٠,٤٤، ٠,٦١، ٠,٨٣، ٠,٩٤ م.ث<sup>-١</sup> وقد تم التوصل الى مجموعة من النتائج يمكن توضيحها فيما يلى:- زيادة القدرة على عمود الجر لآلة المركبة بدون تشغيل الوحدة الدورانية من ٢,٤٣ الى ٤,٤١، ٦,٩٠٥، ٨,٨٤٣، ١٧ سم وكذلك من ٤,٤٥٥ الى ٧,٣٩٦، ١٠,٧٢٢، ١٣,٩٥ ك وات عند عمق تشغيل ٢٢ سم بزيادة السرعة من التشغيل من ٠,٤٤، ٠,٦١، ٠,٨٣، ٠,٩٤ م.ث<sup>-١</sup> على التوالى. تشغيل الوحدة الدورانية ادى الى تقليل القدرة على عمود الجر الى ١,١٥ الى ٢,١٣٤، ٣,٢٤٩، ٤,١٢٤ ك وات عند عمق تشغيل ١٧ سم وكذلك من ٢,٠٧٣ الى ٣,٢٦٥، ٤,٩٧٥، ٦,١٩٤ ك وات عند عمق تشغيل ٢٢ سم عند سرعات تشغيل ٠,٤٤، ٠,٦١، ٠,٨٣، ٠,٩٤ م.ث<sup>-١</sup> على التوالى. قدرت الطاقة النوعية لتشغيل الآلة المركبة عند عمق تشغيل ١٧ سم فكانت ٣٨، ٣٢، ٣٧، ٨٣، ٤٤، ٧١، ٤٤، ٦٧، ٤٧ ميجا جول/فدان وكذلك ٥٦,٨٩، ٥٩,٤٣، ٨٨، ٦٤، ١٦، ٦٦ ميجا جول/فدان عند عمق تشغيل ٢٢ سم عند سرعات تشغيل ٠,٤٤، ٠,٦١، ٠,٨٣، ٠,٩٤ م.ث<sup>-١</sup> على التوالى.